

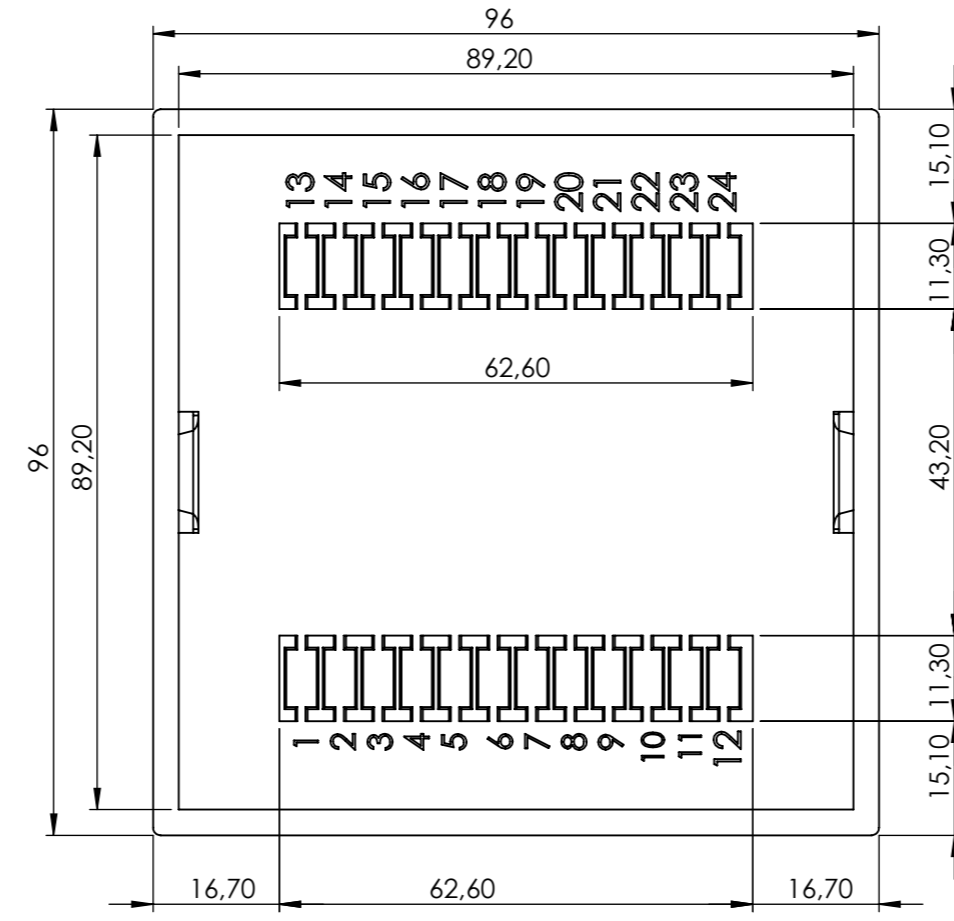

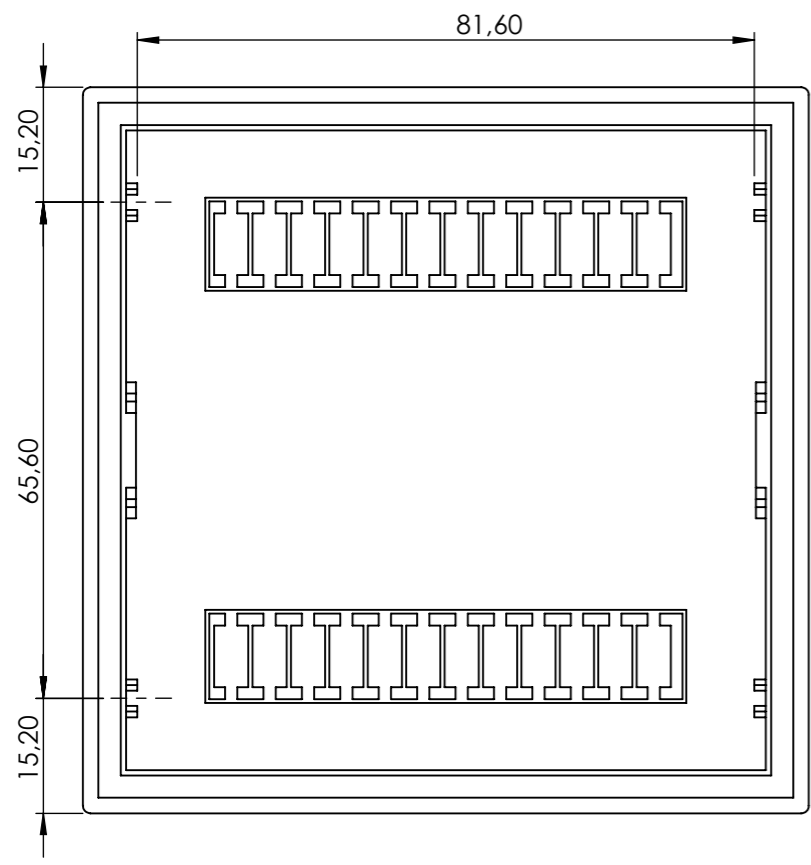

	NAME	DATE	ARTICLE NO:	REVISION:	TITLE:	
DRAWN	Dursun CAN					
CHECKED	Ali Altınışık		COMMENTS:			
 ALTINKAYA ENCLOSURES FOR ELECTRONICS www.altinkaya.com.tr			DIMENSIONS ARE IN MILLIMETERS. DEBUR AND BREAK SHARP EDGES			
PROPRIETARY AND CONFIDENTIAL THE INFORMATION CONTAINED IN THIS DRAWING IS THE SOLE PROPERTY OF ALTINKAYA ENCLOSURES. ANY REPRODUCTION IN PART OR AS A WHOLE WITHOUT THE WRITTEN PERMISSION OF ALTINKAYA ENCLOSURES IS PROHIBITED.			DWG NO. Pt-220-Assembly			A4
MATERIAL:			WEIGHT:		SCALE:1:5	SHEET 1 OF 1

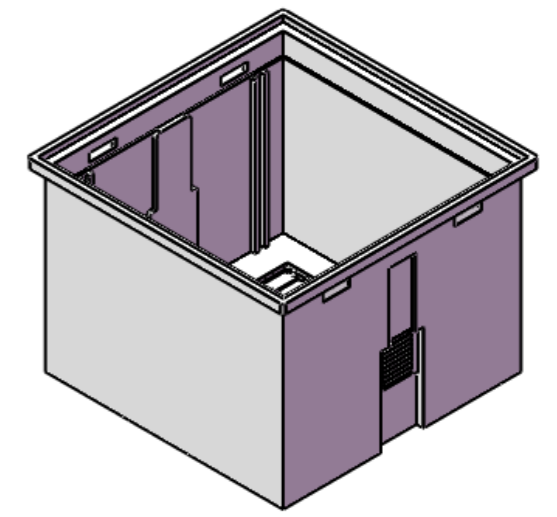

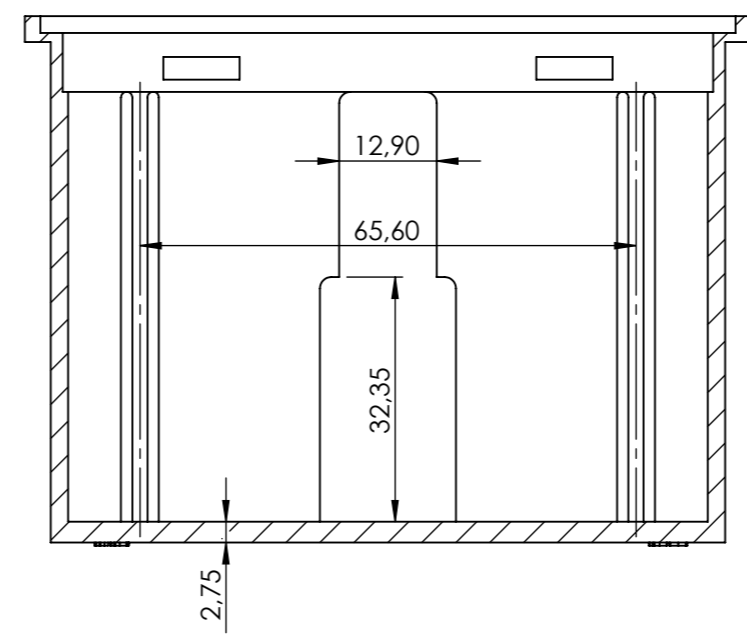
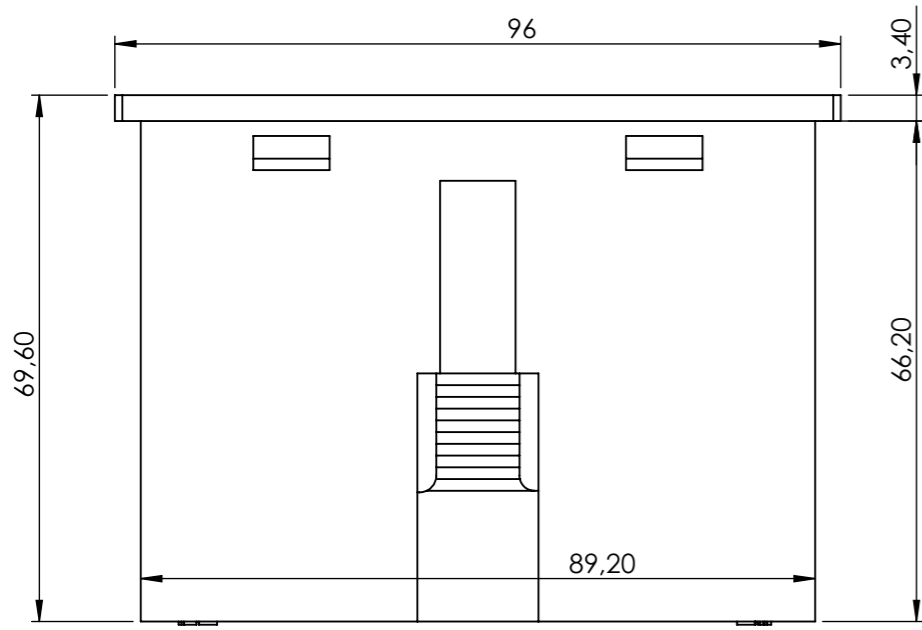

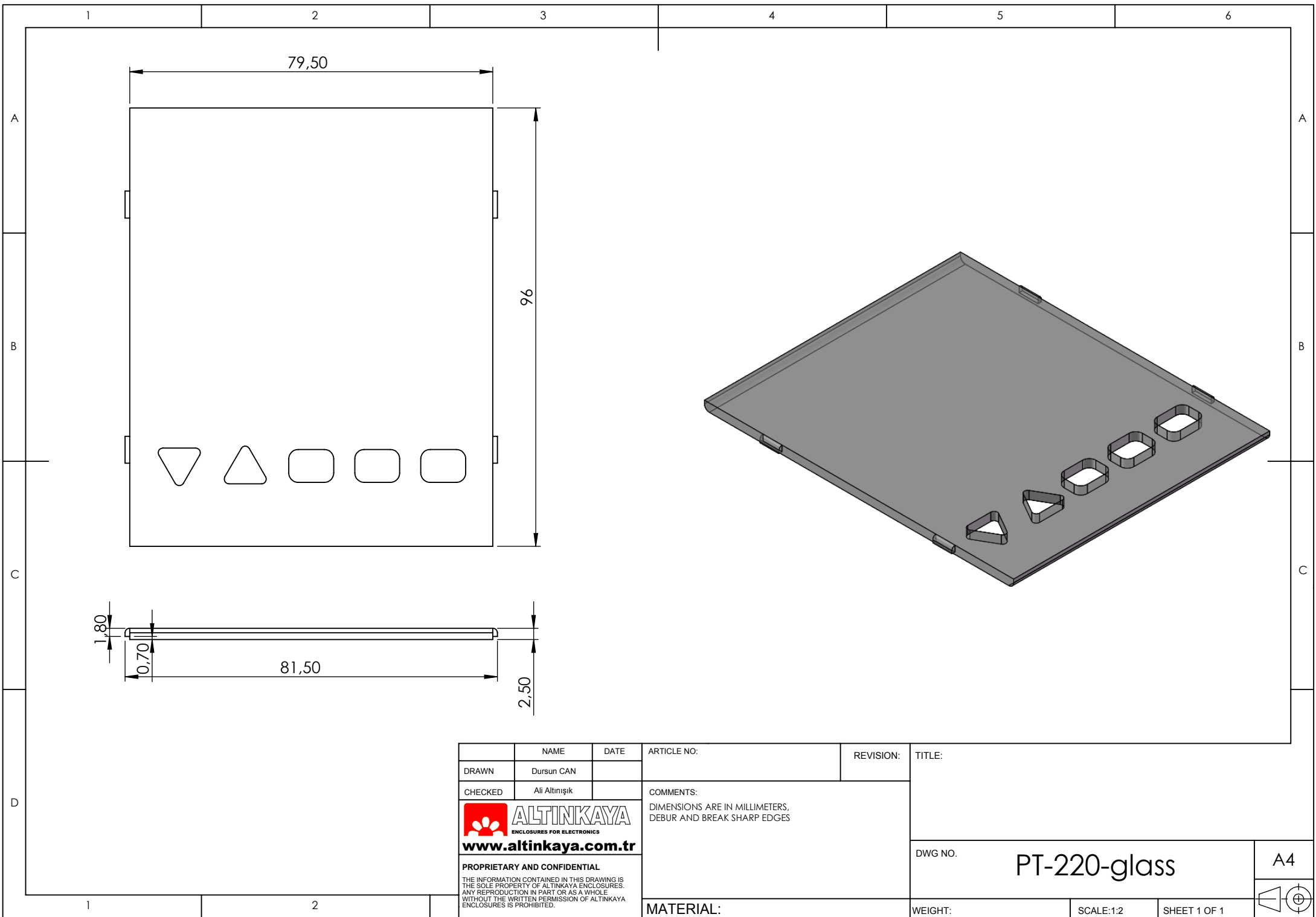
<small>PROPRIETARY AND CONFIDENTIAL THE INFORMATION CONTAINED IN THIS DRAWING IS THE SOLE PROPERTY OF ALTINKAYA ENCLOSURES. ANY REPRODUCTION IN PART OR AS A WHOLE WITHOUT THE WRITTEN PERMISSION OF ALTINKAYA ENCLOSURES IS PROHIBITED.</small>		ARTICLE NO.:	REVISION:
DRAWN: Dursun CAN CHECKED: Ali Altınışık COMMENTS:	NAME: DATE: Ali Altınışık	 ALTINKAYA <small>ENCLOSURES FOR ELECTRONICS</small>	CONTACT: www.altinkaya.com.tr
MATERIAL:	DWG NO. PT-220-Body		A3
WEIGHT:	SCALE: 1:2	SHEET 1 OF 1	

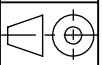

	NAME	DATE	ARTICLE NO:	REVISION:	TITLE:
DRAWN	Dursun CAN				
CHECKED	Ali Altınışık		COMMENTS:		
 ALTINKAYA ENCLOSURES FOR ELECTRONICS www.altinkaya.com.tr			DIMENSIONS ARE IN MILLIMETERS. DEBUR AND BREAK SHARP EDGES		
PROPRIETARY AND CONFIDENTIAL <small>THE INFORMATION CONTAINED IN THIS DRAWING IS THE SOLE PROPERTY OF ALTINKAYA ENCLOSURES. ANY REPRODUCTION IN PART OR AS A WHOLE WITHOUT THE WRITTEN PERMISSION OF ALTINKAYA ENCLOSURES IS PROHIBITED.</small>			DWG NO. PT-220-glass		A4
			MATERIAL:	WEIGHT:	SCALE:1:2
					SHEET 1 OF 1

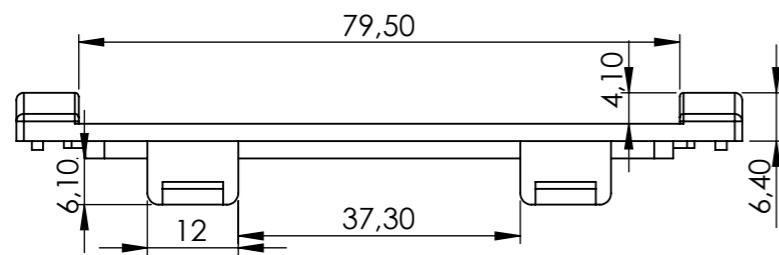
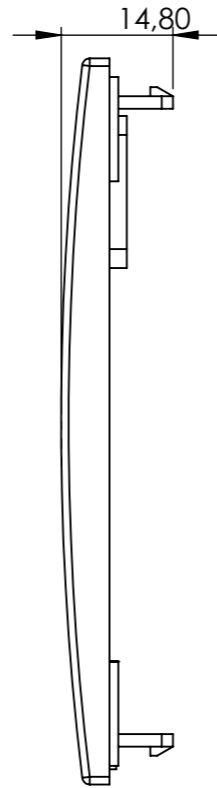
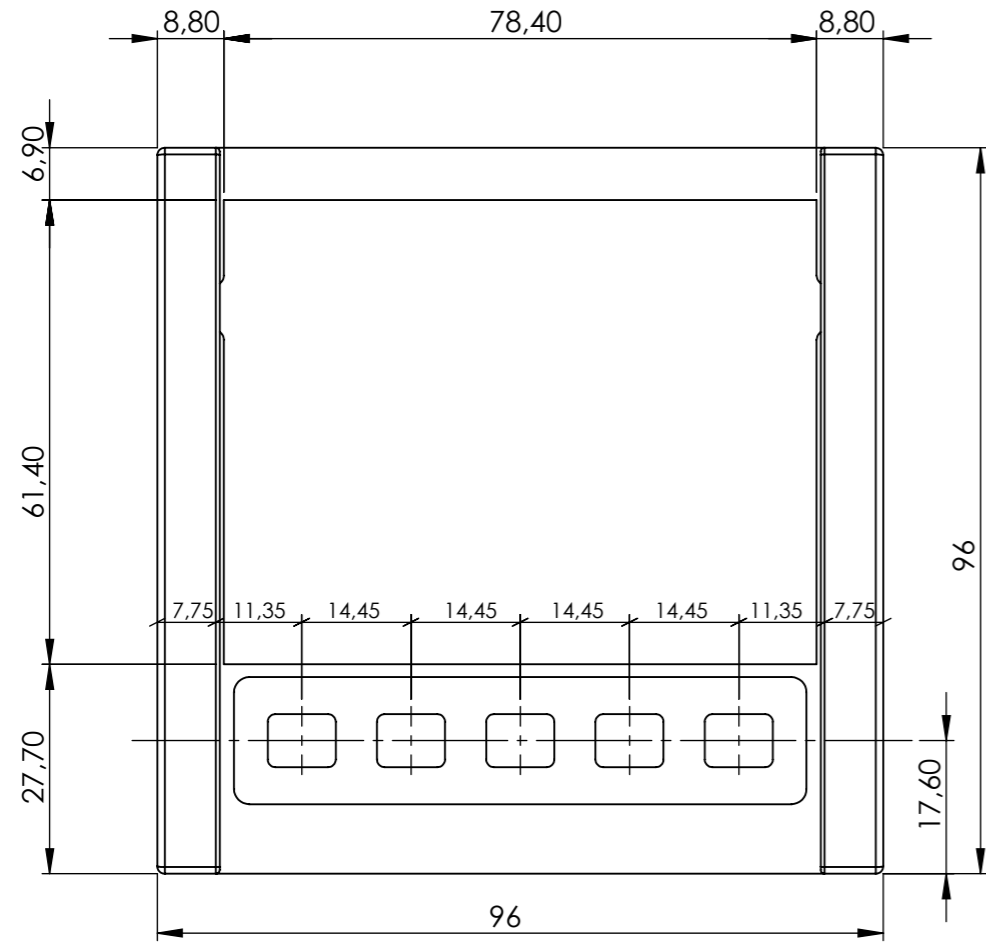



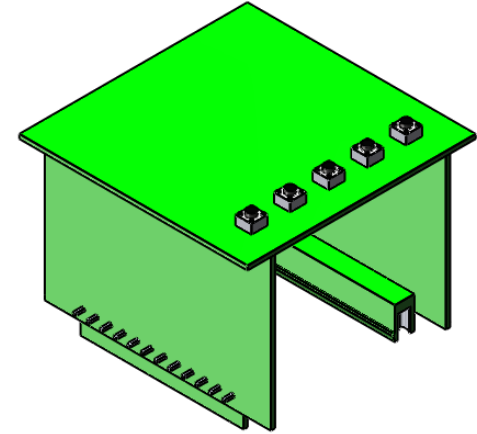
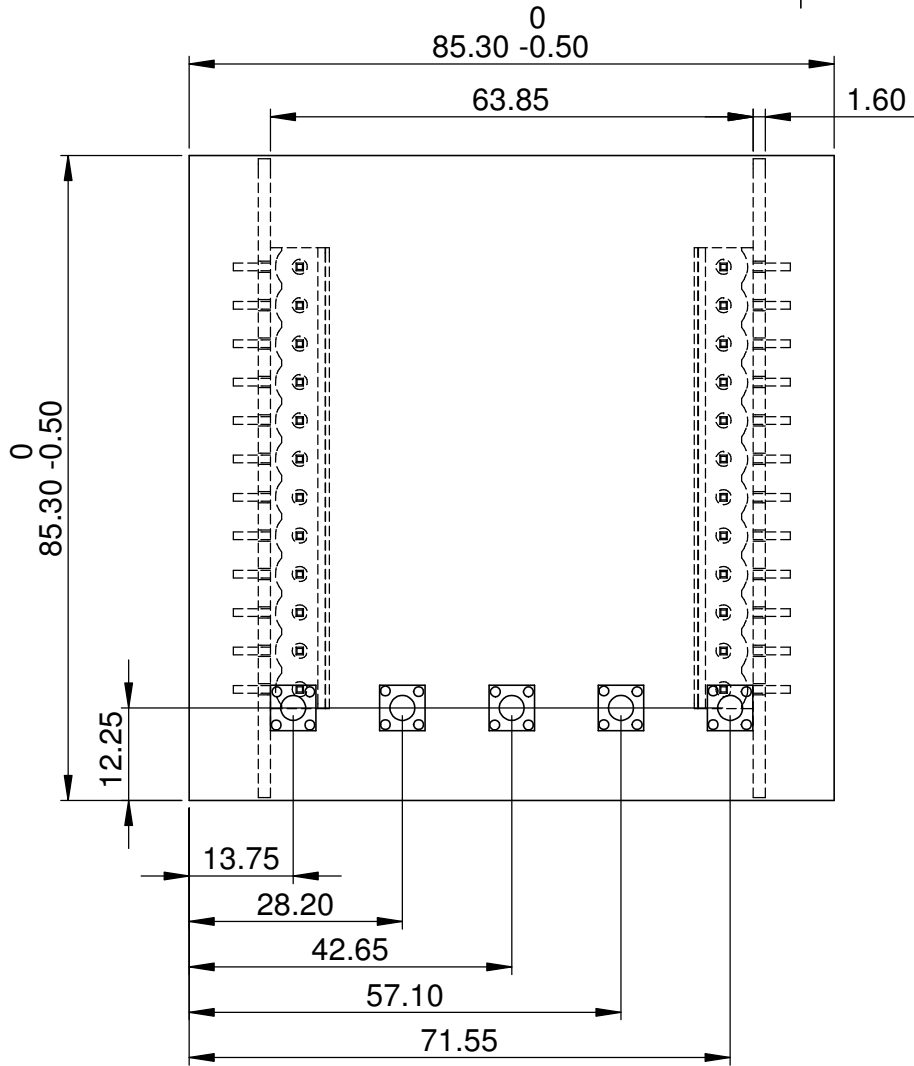

<small>PROPRIETARY AND CONFIDENTIAL THE INFORMATION CONTAINED IN THIS DRAWING IS THE SOLE PROPERTY OF ALTINKAYA ENCLOSURES. ANY REPRODUCTION IN PART OR AS A WHOLE WITHOUT THE WRITTEN PERMISSION OF ALTINKAYA ENCLOSURES IS PROHIBITED.</small>		ARTICLE NO:	REVISION:
<small>DRAWN</small> Dursun CAN		 ALTINKAYA ENCLOSURES FOR ELECTRONICS	CONTACT: www.altinkaya.com.tr
<small>CHECKED</small> Ali Altınışık		TITLE:	
COMMENTS:		DWG NO. PT-220-Panel	
MATERIAL:		A3	
WEIGHT:		SCALE:1:2	SHEET 1 OF 1



	NAME	DATE	ARTICLE NO:	REVISION:	TITLE:
DRAWN	Dursun Daşdemir				Top Pcb Sample (Not Included)
CHECKED	Ali Altınışık		COMMENTS: This drawing is subject to technical modification without prior notice. Typographical and other errors do not justify any claims for damages. All dimensions should be verified using an actual produced part.		
 ALTINKAYA ENCLOSURES FOR ELECTRONICS www.altinkaya.com.tr			DİKKAT: BU RESİM VE ÜRÜN ÖNCEDEN HABER VERİLMEKSİZİN DEĞİŞTİRİLEBİLİR. RESİM ÇİZİLİRKEN HATALAR BULUNABİLİR. ÇALIŞILMASINA RAĞMEN RESİMDE HATALAR BULUNABİLİR. RESİMDEKİ HATALARDAN DOLAYI OLUŞABİLECEK ZARARLAR İÇİN ALTINKAYA HİÇ BİR SORUMLULUK KABUL ETMEZ. BÜTÜN ÖLÇÜLER KULLANILMADAN ÖNCE ÜRETİLMİŞ GERÇEK BİR NUMUNEDEN KONTROL EDİLMELİDİR.		DWG NO.
PROPRIETARY AND CONFIDENTIAL THE INFORMATION CONTAINED IN THIS DRAWING IS THE SOLE PROPERTY OF ALTINKAYA ENCLOSURES. ANY REPRODUCTION IN PART OR AS A WHOLE WITHOUT THE WRITTEN PERMISSION OF ALTINKAYA ENCLOSURES IS PROHIBITED.			MATERIAL:		A4
			WEIGHT:		SCALE:1:1
			SHEET OF		

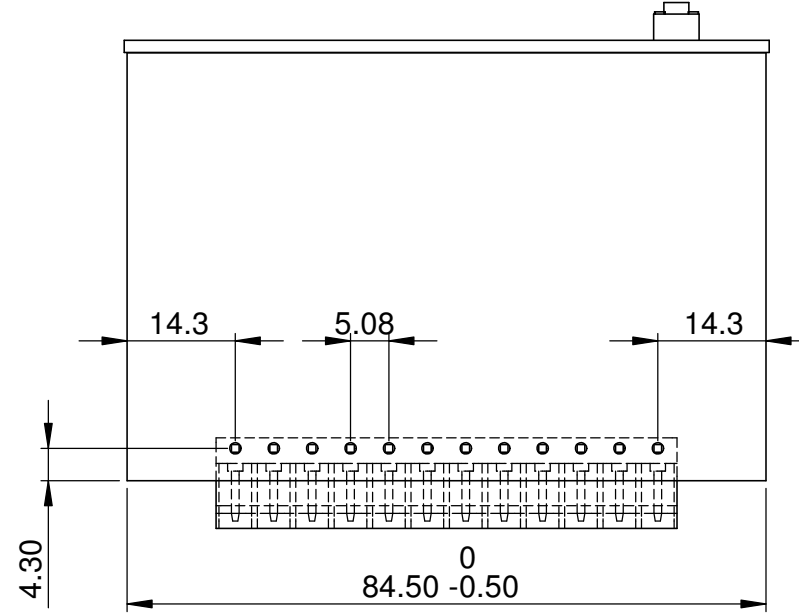
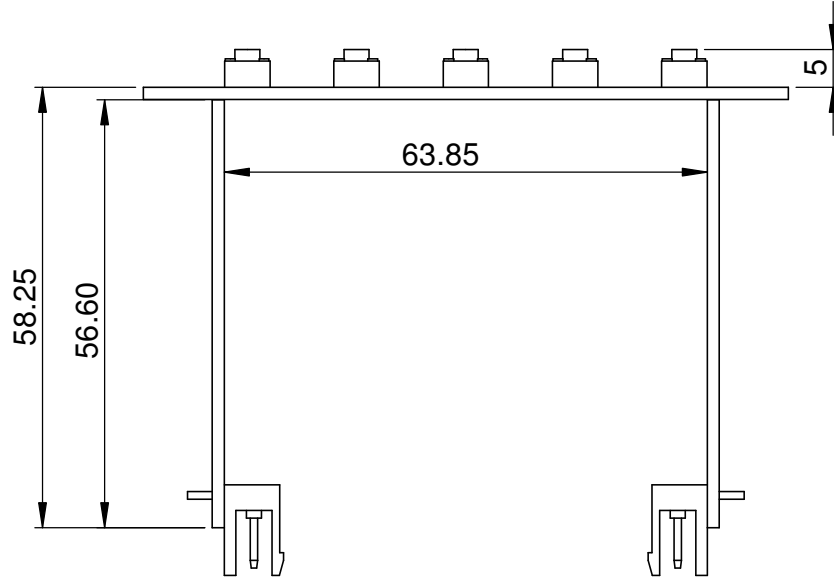



NAME	DATE	ARTICLE NO:	REVISION:	TITLE:
DRAWN Dursun Daşdemir				Right-Left Pcb Sample (Not Included)
CHECKED Ali Altınışık		COMMENTS: This drawing is subject to technical modification without prior notice. Typographical and other errors do not justify any claims for damages. All dimensions should be verified using an actual produced part.		
 www.altinkaya.com.tr		DİKKAT: BU RESİM VE ÜRÜN ÖNCEDEN HABER VERİLMEKSİZİN DEĞİŞTİRİLEBİLİR. RESİM ÇİZİLİRKEN HATASIZ OLMASINA ÇALIŞILMASINA RAĞMEN RESİMDE HATALAR BULUNABİLİR. RESİMDEKİ HATALARDAN DOLAYI OLUŞABİLECEK ZARARLAR İÇİN ALTINKAYA HIÇ BİR SORUMLULUK KABUL ETMEZ. BÜTÜN ÖLÇÜLER KULLANILMADAN ÖNCE ÜRETİLMİŞ GERÇEK BİR NUMUNEDEN KONTROL EDİLMELİDİR.		DWG NO:
PROPRIETARY AND CONFIDENTIAL THE INFORMATION CONTAINED IN THIS DRAWING IS THE SOLE PROPERTY OF ALTINKAYA ENCLOSURES. ANY REPRODUCTION IN PART OR AS A WHOLE WITHOUT THE WRITTEN PERMISSION OF ALTINKAYA ENCLOSURES IS PROHIBITED.		MATERIAL:	WEIGHT:	SCALE:1:1
				SHEET OF

A4

