

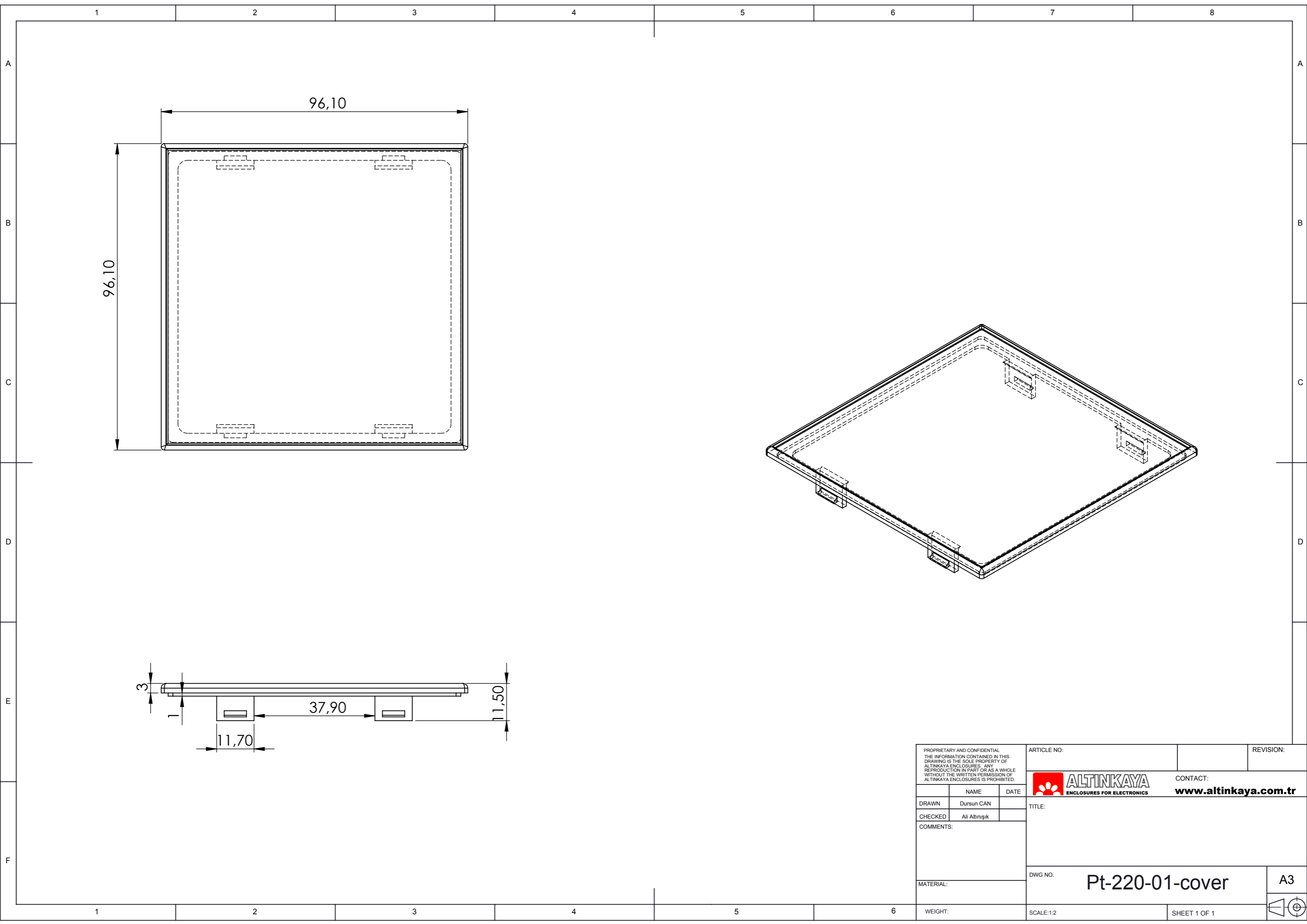



<small>PROPRIETARY AND CONFIDENTIAL THE INFORMATION CONTAINED IN THIS DRAWING IS THE SOLE PROPERTY OF ALTINKAYA ENCLOSURES. ANY REPRODUCTION IN PART OR AS A WHOLE WITHOUT THE WRITTEN PERMISSION OF ALTINKAYA ENCLOSURES IS PROHIBITED.</small>			ARTICLE NO.:	REVISION:
<small>DRAWN</small> Dursun CAN <small>CHECKED</small> Ali Altınışık <small>COMMENTS:</small> <small>MATERIAL:</small> <small>WEIGHT:</small>			 ALTINKAYA <small>ENCLOSURES FOR ELECTRONICS</small>	<small>CONTACT:</small> www.altinkaya.com.tr
			<small>TITLE:</small>	
			<small>DWG NO.</small> Pt-220-01-,Assembly	A3
			<small>SCALE:</small> 1:5	<small>SHEET</small> 1 OF 1



<small>PROPRIETARY AND CONFIDENTIAL THE INFORMATION CONTAINED IN THIS DRAWING IS THE SOLE PROPERTY OF ALTINKAYA ENCLOSURES. ANY REPRODUCTION IN PART OR AS A WHOLE WITHOUT THE WRITTEN PERMISSION OF ALTINKAYA ENCLOSURES IS PROHIBITED.</small>			ARTICLE NO:	REVISION:
<small>DRAWN</small> Dursun CAN				CONTACT: www.altinkaya.com.tr
<small>CHECKED</small> Ali Altınışık				TITLE:
<small>COMMENTS:</small>			DWG NO.	Pt-220-01-cover
<small>MATERIAL:</small>			SCALE:1:2	A3
<small>WEIGHT:</small>			SHEET 1 OF 1	

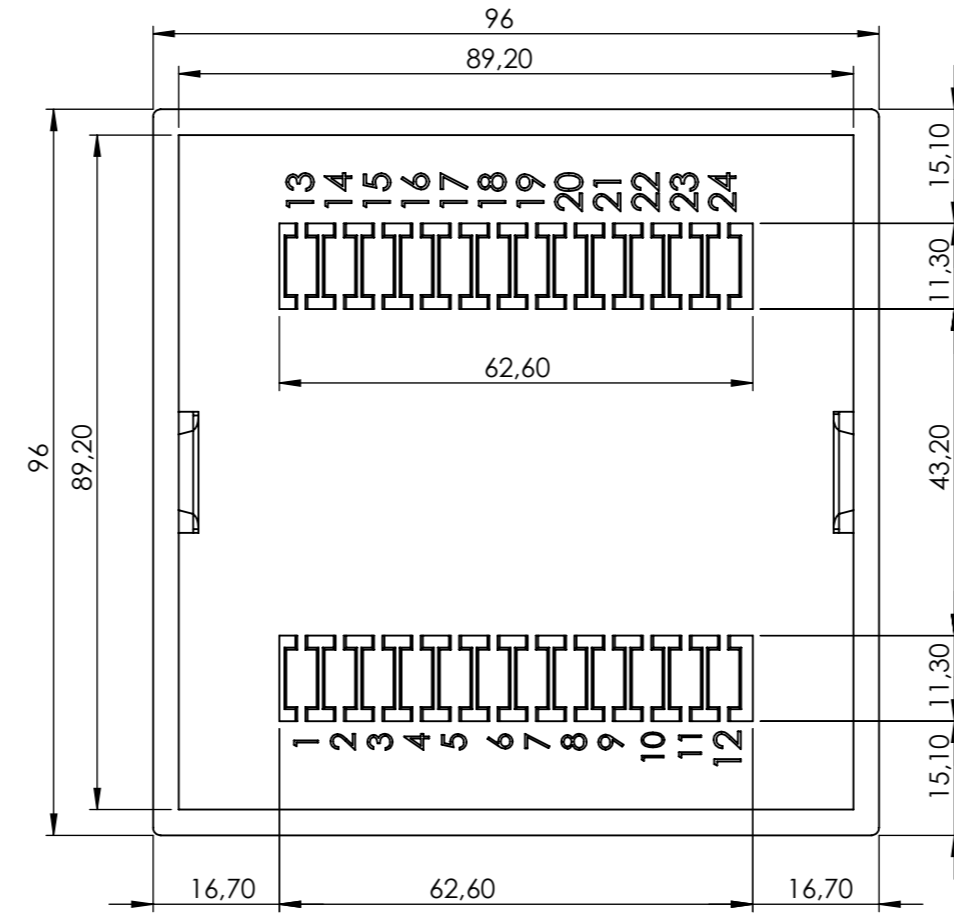
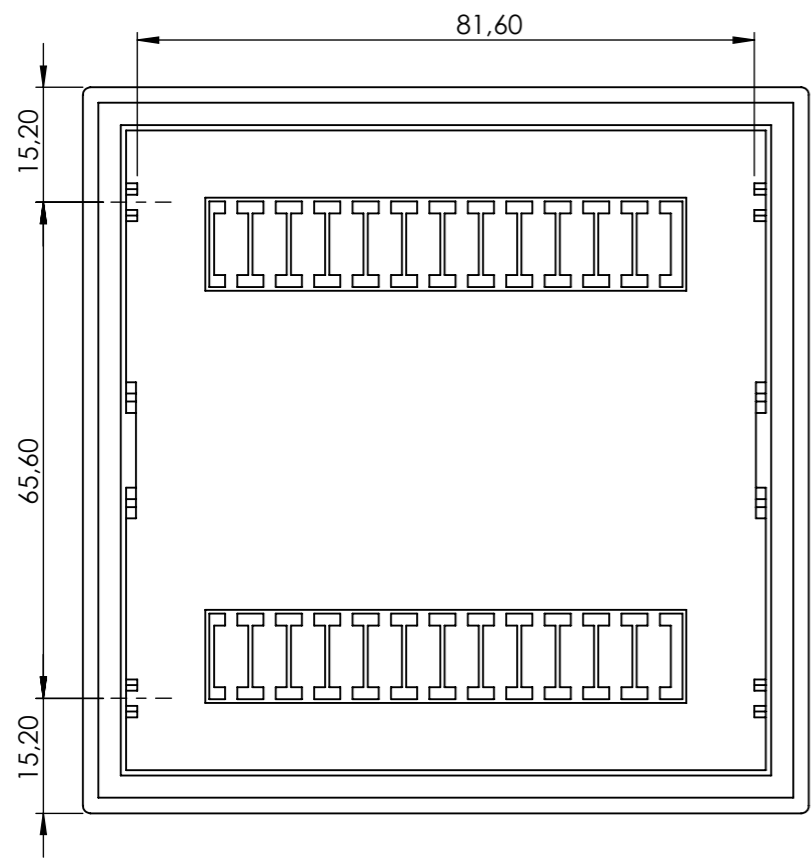
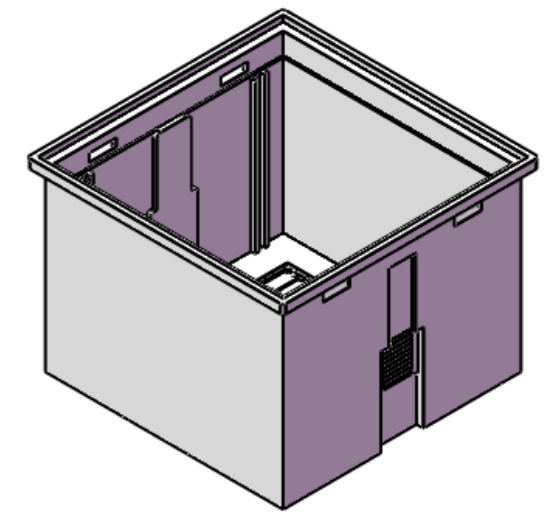
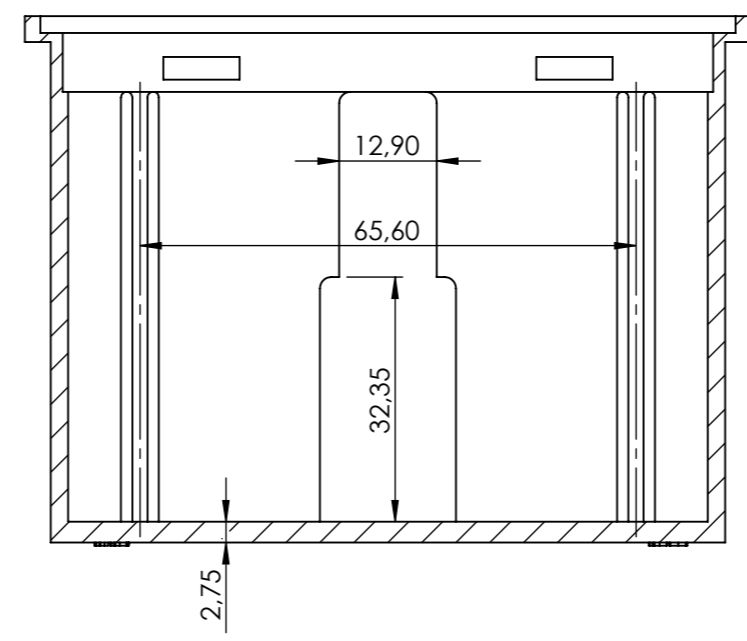
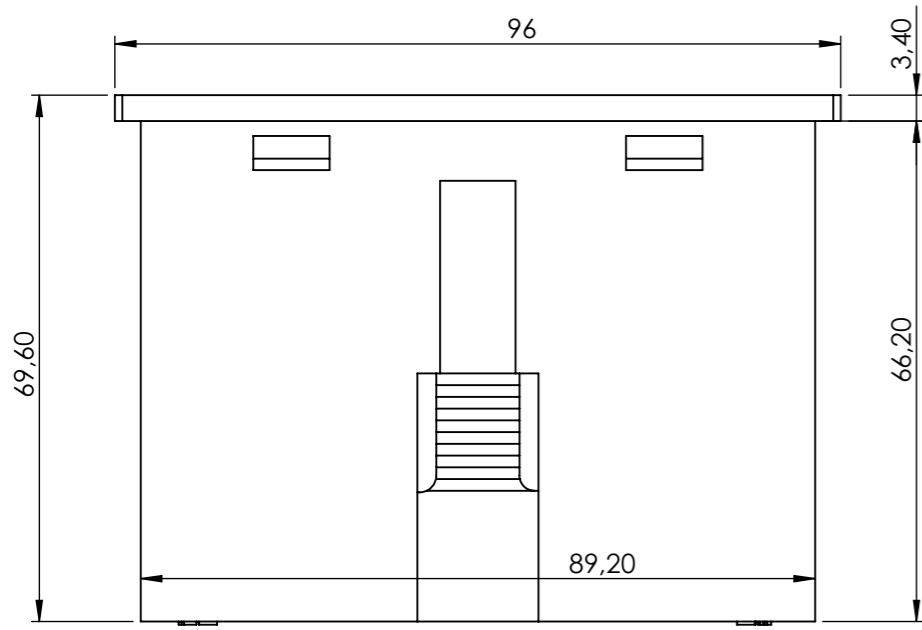

<small>PROPRIETARY AND CONFIDENTIAL THE INFORMATION CONTAINED IN THIS DRAWING IS THE SOLE PROPERTY OF ALTINKAYA ENCLOSURES. ANY REPRODUCTION IN PART OR AS A WHOLE WITHOUT THE WRITTEN PERMISSION OF ALTINKAYA ENCLOSURES IS PROHIBITED.</small>		ARTICLE NO.:	REVISION:
DRAWN: Dursun CAN CHECKED: Ali Altınışık COMMENTS:	NAME: Dursun CAN DATE: CONTACT: www.altinkaya.com.tr		
MATERIAL:	TITLE:	DWG NO. PT-220-Body	A3
WEIGHT:	SCALE: 1:2	SHEET 1 OF 1	

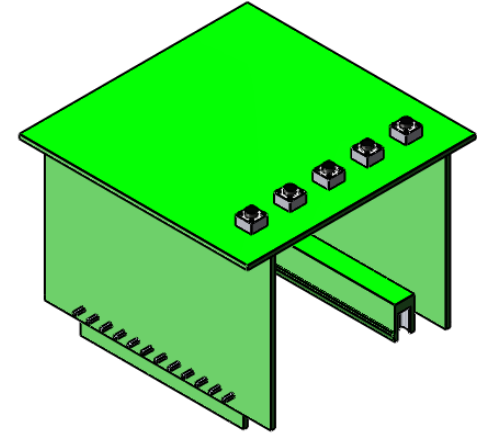
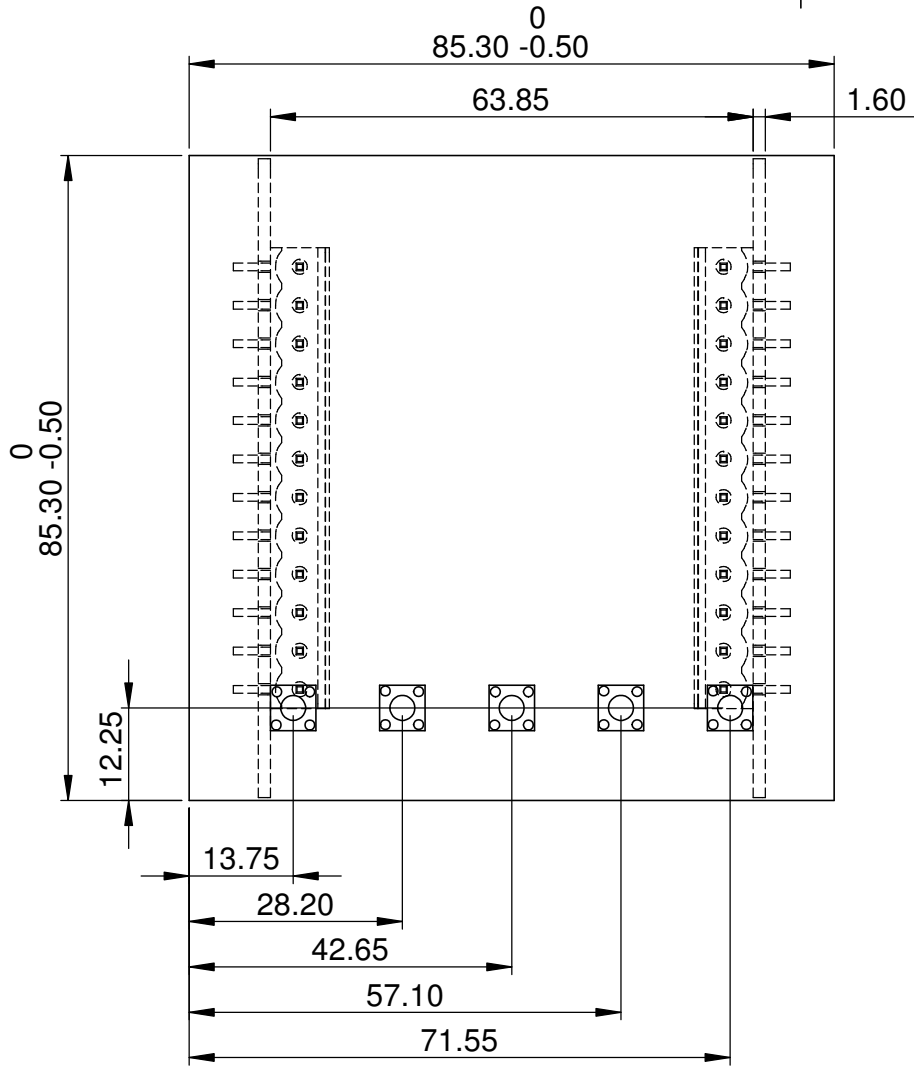

NAME	DATE	ARTICLE NO:	REVISION:	TITLE:
DRAWN	Dursun Daşdemir			Top Pcb Sample (Not Included)
CHECKED	Ali Altınışık			
 ALTINKAYA ENCLOSURES FOR ELECTRONICS www.altinkaya.com.tr		COMMENTS: This drawing is subject to technical modification without prior notice. Typographical and other errors do not justify any claims for damages. All dimensions should be verified using an actual produced part. DİKKAT: BU RESİM VE ÜRÜN ÖNCEDEN HABER VERİLMEKSİZİN DEĞİŞTİRİLEBİLİR. RESİM ÇİZİLİRKEN HATALAR OLMASINA ÇALIŞILMASINA RAĞMEN RESİMDE HATALAR BULUNABİLİR. RESİMDEKİ HATALARDAN DOLAYI OLUŞABİLECEK ZARARLAR İÇİN ALTINKAYA HİÇ BİR SORUMLULUK KABUL ETMEZ. BÜTÜN ÖLÇÜLER KULLANILMADAN ÖNCE ÜRETİLMİŞ GERÇEK BİR NUMUNEDEN KONTROL EDİLMELİDİR.		DWG NO.
PROPRIETARY AND CONFIDENTIAL THE INFORMATION CONTAINED IN THIS DRAWING IS THE SOLE PROPERTY OF ALTINKAYA ENCLOSURES. ANY REPRODUCTION IN PART OR AS A WHOLE WITHOUT THE WRITTEN PERMISSION OF ALTINKAYA ENCLOSURES IS PROHIBITED.		MATERIAL:		A4 
		WEIGHT:		SCALE:1:1 SHEET OF

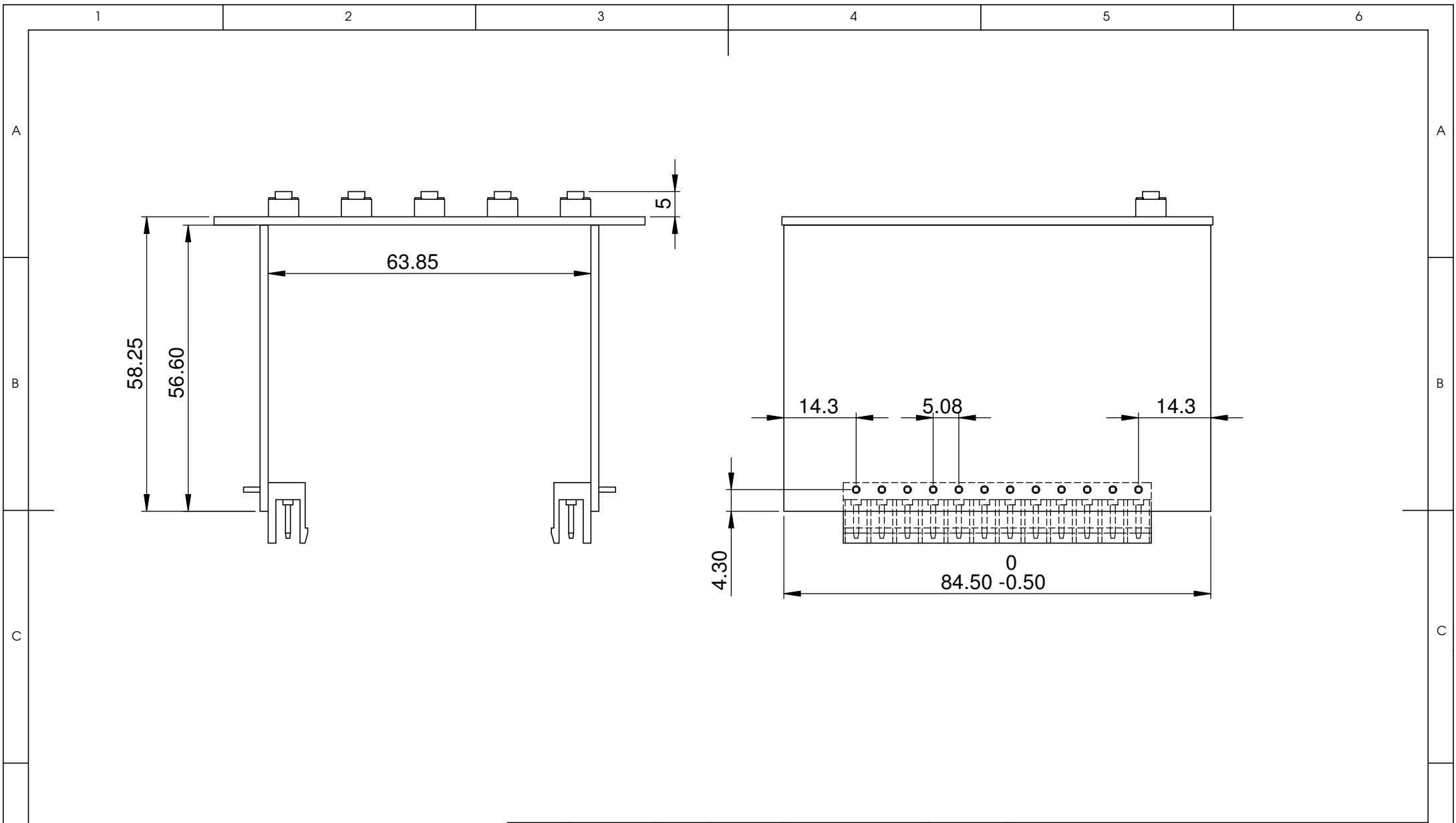

	NAME	DATE	ARTICLE NO:	REVISION:	TITLE:	<h2>Right-Left Pcb Sample (Not Included)</h2>
DRAWN	Dursun Daşdemir					
CHECKED	Ali Altınışık		COMMENTS: This drawing is subject to technical modification without prior notice. Typographical and other errors do not justify any claims for damages. All dimensions should be verified using an actual produced part.			
 www.altinkaya.com.tr			DİKKAT: BU RESİM VE ÜRÜN ÖNCEDEN HABER VERİLMEKSİZİN DEĞİŞTİRİLEBİLİR. RESİM ÇİZİLİRKEN HATASIZ OLMASINA ÇALIŞILMASINA RAĞMEN RESİMDE HATALAR BULUNABİLİR. RESİMDEKİ HATALARDAN DOLAYI OLUŞABİLECEK ZARARLAR İÇİN ALTINKAYA HİÇ BİR SORUMLULUK KABUL ETMEZ. BÜTÜN ÖLÇÜLER KULLANILMADAN ÖNCE ÜRETİLMİŞ GERÇEK BİR NUMUNEDEN KONTROL EDİLMELİDİR.		DWG NO.	A4
PROPRIETARY AND CONFIDENTIAL THE INFORMATION CONTAINED IN THIS DRAWING IS THE SOLE PROPERTY OF ALTINKAYA ENCLOSURES. ANY REPRODUCTION IN PART OR AS A WHOLE WITHOUT THE WRITTEN PERMISSION OF ALTINKAYA ENCLOSURES IS PROHIBITED.			MATERIAL:	WEIGHT:	SCALE:1:1	SHEET OF